

ALL DIMENSIONS ARE IN METER

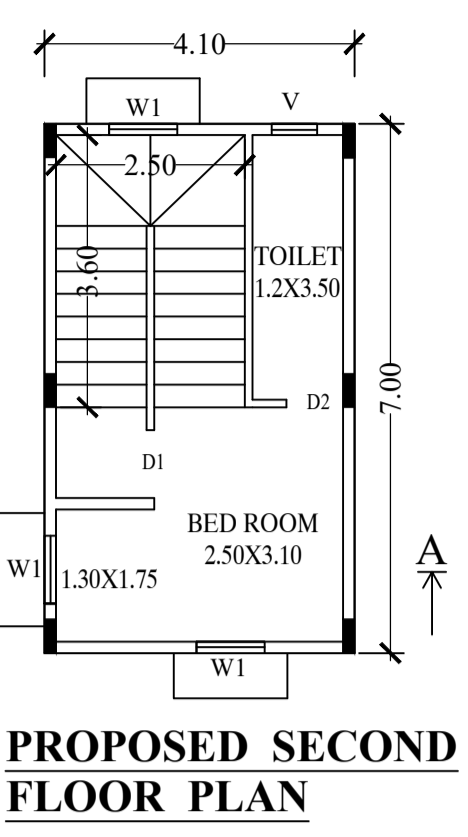
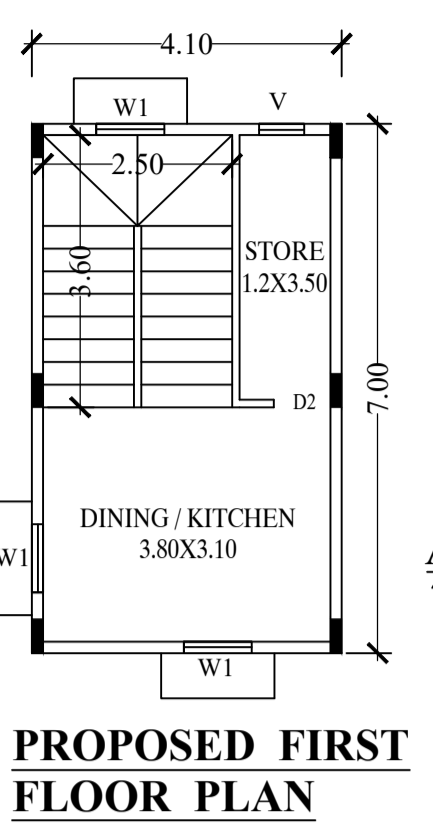
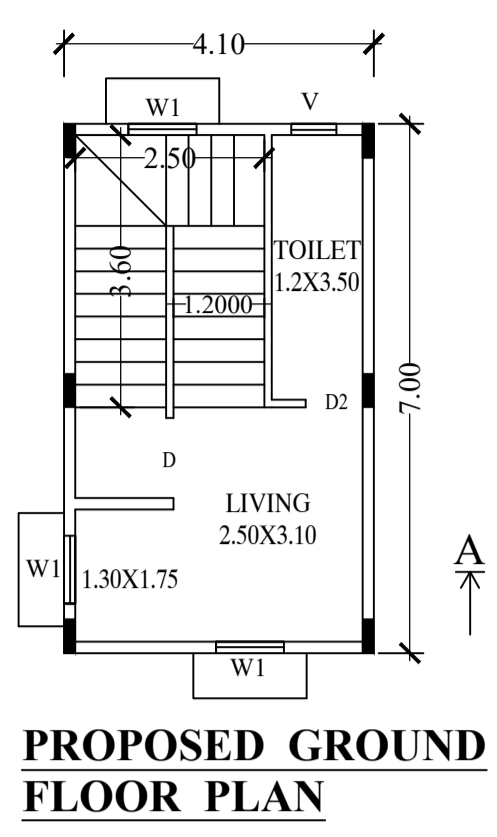
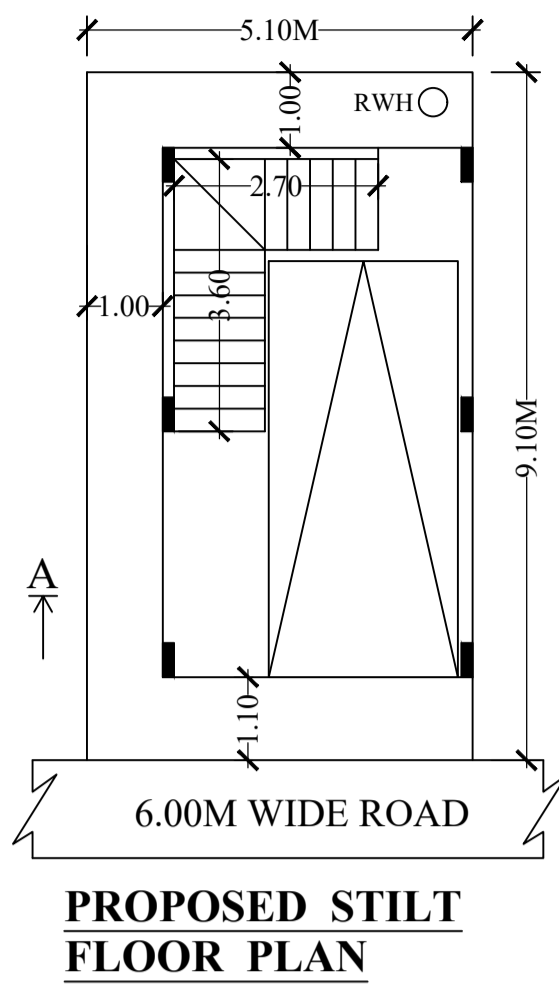

Approval Condition :

This Plan Sanction is issued subject to the following conditions :

- The sanction is accorded for a) Consisting of Block - A (A) Wing - A-1 (A) Consisting of STILT, GF-ZUF.
- The sanction is accorded for Bungalow A (A) only. The use of the building shall not deviate to any other use.
- Car Parking reserved in the plan should not be converted for any other purpose.
- Development charges towards increasing the capacity of water supply, sanitary and power main has to be paid to BWSSB and BESCOM if any.
- Necessary ducts for running telephone cables, cubicles at ground level for postal services & space for dumping garbage within the premises shall be provided.
- The applicant shall construct temporary toilets for the use of construction workers and it should be demolished after the construction.
- The applicant shall INSURE all workmen involved in the construction work against any accident / untoward incidents arising during the time of construction.
- The applicant shall not stock any building materials / debris on footpath or on roads or on drains. The debris shall be removed and transported to near by dumping yard.
- The applicant / builder is prohibited from selling the setback area / open spaces and the common facility areas, which shall be accessible to all the tenants and occupants.
- The applicant shall provide a space for locating the distribution transformers & associated equipment as per K.E.R.C (E&D) code leaving 3.00 mts. from the building within the premises.
- The applicant shall provide a separate room preferably 4.50 x 3.65 m in the basement for installation of telecom equipment and also to make provisions for telecom services as per Bye-law No. 25.

- Sufficient two wheeler parking shall be provided as per requirement.
- Traffic Management Plan shall be obtained from Traffic Management Consultant for all high rise structures which shall be got approved from the Competent Authority if necessary.
- The Owner / Association of high-rise building shall obtain clearance certificate from Karnataka Fire and Emergency Department every Two years with due inspection by the department regarding working condition of Fire Safety Measures installed. The certificate should be produced to the Corporation and shall get the renewal of the permission issued once in Two years.
- The Owner / Association of high-rise building shall get the building inspected by empanelled agencies of the Karnataka Fire and Emergency Department to ensure that the equipment's installed are in good and workable condition, and an affidavit to that effect shall be submitted to the Corporation and Fire Force Department every year.
- The Owner / Association of high-rise building shall obtain clearance certificate from the Electrical Inspectorate every Two years with due inspection by the Department regarding working condition of Electrical installation / Lifts etc. The certificate should be produced to the BBMP and shall get the renewal of the permission issued that once in Two years.
- The Owner / Association of the high-rise building shall conduct two mock - trials in the building - one before the onset of summer and another during the summer and assure complete safety in respect of fire hazards.
- The Builder / Contractor / Professional responsible for supervision of work shall not shall not materially and structurally deviate the construction from the sanctioned plan, without previous approval of the authority. They shall explain to the owner s about the risk involved in contravention of the provisions of the Act, Rules, Bye-laws, Zoning Regulations, Standing Orders and Policy Orders of the BBMP.
- The construction or reconstruction of a building shall be commenced within a period of two (2) years from date of issue of licence. Before the expiry of two years, the Owner / Developer shall give intimation to BBMP (Sanctioning Authority) of the intention to start work in the form prescribed in Schedule VI. Further, the Owner / Developer shall give intimation on completion of the foundation or footing of walls / columns of the foundation. Otherwise the plan sanction deemed cancelled.
- In case of Development plan, Parks and Open Spaces Area and Surface Parking area shall be earmarked and reserved as per Development Plan issued by the Bangalore Development Authority.
- All other conditions and conditions mentioned in the work order issued by the Bangalore Development Authority while approving the Development Plan for the project should be strictly adhered to.
- The Applicant / Owner / Developer shall abide by the collection of solid waste and its segregation as per solid waste management bye-law 2016.
- The applicant/owner/developer shall abide by sustainable construction and demolition waste management as per solid waste management bye-law 2016.
- The Applicant / Owners / Developers shall make necessary provision to charge electrical vehicles.
- The Applicant / Owner / Developer shall plant one tree for a) sites measuring 180 Sqm up to 240 Sqm b) minimum of two trees for sites measuring with more than 240 Sqm. c) One tree for every 240 Sqm of the FAR area as part thereof in case of Apartment / group housing / multi-dwelling unit/development plan.
- In case of any false information, misrepresentation of facts, or pending court cases, the plan sanction is deemed cancelled.
- Also see, building licence for special conditions, if any.

- Registration of Applicant / Builder / Owner / Contractor and the construction workers working in the construction site with the "Karnataka Building and Other Construction workers Welfare Board" should be strictly adhered to.
- The Applicant / Builder / Owner / Contractor should submit the Registration of establishment and list of construction workers engaged at the time of issue of Commencement Certificate. A copy of the same shall also be submitted to the concerned local Engineer in order to inspect the establishment and ensure the registration of establishment and workers working at construction site or work place.
- The Applicant / Builder / Owner / Contractor shall also inform the changes if any of the list of workers engaged by him.
- At any point of time No Applicant / Builder / Owner / Contractor shall engage a construction worker in his site or work place who is not registered with the "Karnataka Building and Other Construction workers Welfare Board".

Note :

- Accommodation shall be provided for setting up of schools for imparting education to the children of construction workers in the labour camps / construction sites.
- List of children of workers shall be furnished by the builder / contractor to the Labour Department which is mandatory.
- Employment of child labour in the construction activities strictly prohibited.
- Obtaining NOC from the Labour Department before commencing the construction work is a must.
- BBMP will not be responsible for any dispute that may arise in respect of property in question.
- In case if the documents submitted in respect of property in question is found to be false or fabricated, the plan sanctioned stands cancelled automatically and legal action will be initiated.
- The owner / builder should ensure the required safety measures while excavation for basement/foundation and constructing the basement/ foundation/stilt and upper floors with regard to the stability of the structure, safety of the neighbours and construction labourers. Owner/builder will be held responsible for any lapses in this regard.

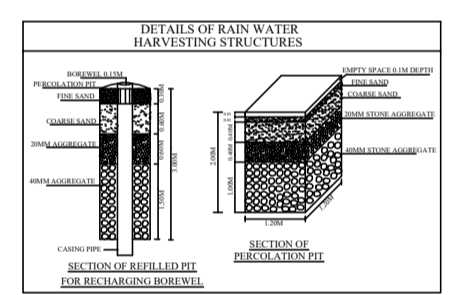
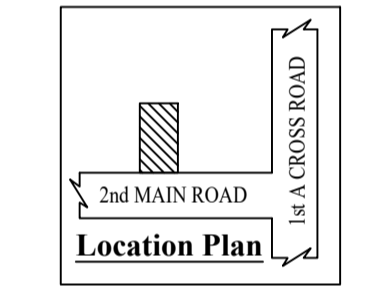
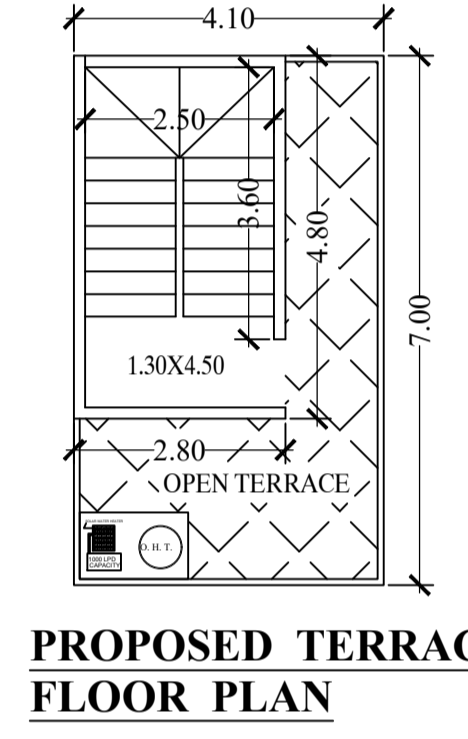
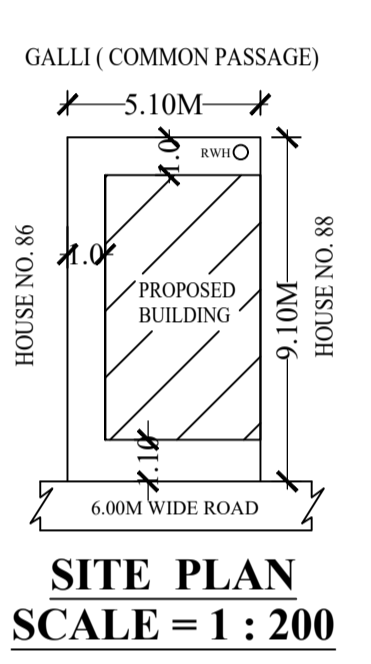
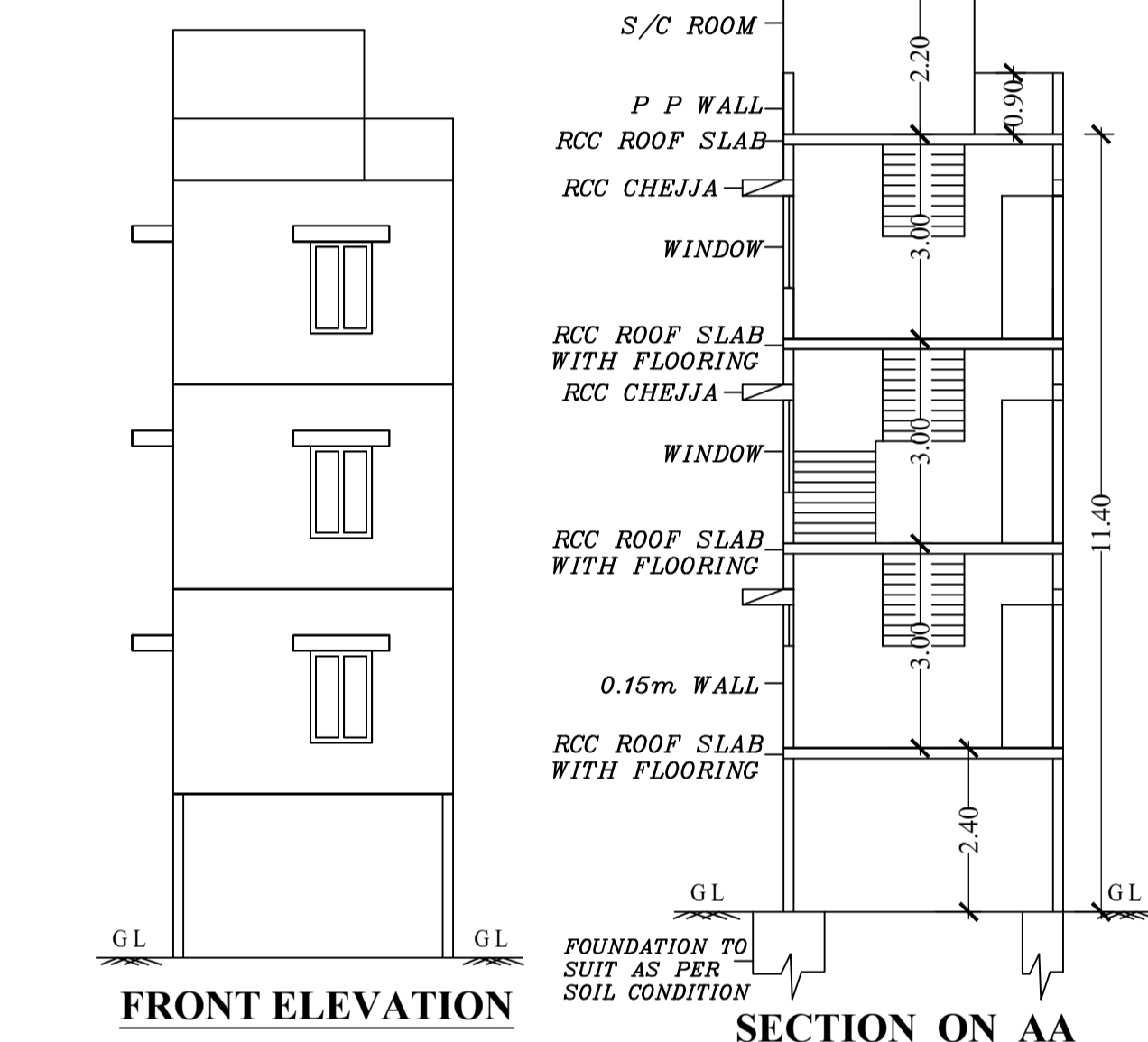

SCHEDULE OF JOINERY:

BLOCK NAME	NAME	LENGTH	HEIGHT	NOS
A (A)	D2	0.75	2.10	03
A (A)	D	1.06	2.10	02

SCHEDULE OF JOINERY:

BLOCK NAME	NAME	LENGTH	HEIGHT	NOS
A (A)	W2	1.20	1.20	04
A (A)	W	2.40	1.20	07

UnitBUA Table for Block :A (A)

FLOOR	Name	UnitBUA Type	UnitBUA Area	Carpet Area	No. of Rooms	No. of Tenement
GROUND FLOOR PLAN	SPLIT tenement	FLAT	86.10	76.38	2	1
FIRST FLOOR PLAN	SPLIT tenement	FLAT	0.00	0.00	2	0
SECOND FLOOR PLAN	SPLIT tenement	FLAT	0.00	0.00	2	0
Total:	-	-	86.10	76.38	6	1

Block :A (A)

Floor Name	Total Built Up Area (Sq.mt.)	Deductions (Area in Sq.mt.)		Proposed FAR Area (Sq.mt.)	Total FAR Area (Sq.mt.)	Tnmt (No.)
		Stair/Case	Parking			
Terrace Floor	13.44	13.44	0.00	0.00	0.00	00
Second Floor	28.70	10.44	0.00	18.26	18.26	00
First Floor	28.70	9.00	0.00	19.70	19.70	00
Ground Floor	28.70	10.44	0.00	18.26	18.26	01
Stilt Floor	28.70	6.12	22.58	0.00	0.00	00
Total:	128.24	49.44	22.58	56.22	56.22	01
Total Number of Same Blocks	1					
Total:	128.24	49.44	22.58	56.22	56.22	01

Block USE/SUBUSE Details

Block Name	Block Use	Block SubUse	Block Structure	Block Land Use Category
A (A)	Residential	Bungalow	Bldg upto 11.5 mt. HL	R

Required Parking (Table 7a)

Block Name	Type	SubUse	Area (Sq.mt.)	Units		Car	
				Reqd.	Prop.	Reqd./Unit	Prop.
A (A)	Residential	Bungalow	50 - Z25	1	-	1	-
Total :	-	-	-	-	-	1	1

Parking Check (Table 7b)

Vehicle Type	Reqd.		Achieved	
	No.	Area (Sq.mt.)	No.	Area (Sq.mt.)
Car	1	13.75	1	13.75
Total Car	1	13.75	1	13.75
TwoWheeler	-	0.00	0	0.00
Other Parking	-	-	-	8.83
Total		13.75	22.58	

FAR & Tenement Details

Block	No. of Same Bldg	Total Built Up Area (Sq.mt.)	Deductions (Area in Sq.mt.)		Proposed FAR Area (Sq.mt.)	Total FAR Area (Sq.mt.)	Tnmt (No.)
			Stair/Case	Parking			
A (A)	1	128.24	49.44	22.58	56.22	56.22	01
Grand Total:	1	128.24	49.44	22.58	56.22	56.22	1.00

The plans are approved in accordance with the acceptance for approval by the Assistant Director of town planning (SOUTH) on date: 18/09/2020 vide lp number: BBMP/Ad.Com./SUT/0358/20-21 subject to terms and conditions laid down along with this building plan approval.

This approval of Building plan/ Modified plan is valid for two years from the date of issue of plan and building licence by the competent authority.

ASSISTANT DIRECTOR OF TOWN PLANNING (SOUTH)

BHRUHAT BENGALURU MAHANAGARA PALIKE

AREA STATEMENT (BBMP)		VERSION NO. : 1.0.13
PROJECT DETAIL:		VERSION DATE: 26/06/2020
Authority: BBMP	Plot Use: Residential	
Inward No: BBMP/Ad.Com./SUT/0358/20-21	Plot SubUse: Bungalow	
Application Type: Suvarna Parvangi	Land Use Zone: Residential (Main)	
Proposal Type: Building Permission	Plot/Sub Plot No. : 87	
Nature of Sanction: NEW	Khata No. (As per Khata Extract): 87	
Location: RING-II	Locality / Street of the property: 2nd MAIN, KUMARSWAMY LAYOUT 2nd STAGE EWS HOUSES, BANGALORE.	
Building Line Specified as per Z.R. NA		
Zone: South		
Ward: Ward-182		
Planning District: 211-Banashankari		
AREA DETAILS:		SQ.MT.
AREA OF PLOT (Minimum)	(A)	46.41
NET AREA OF PLOT (A-Deductions)		46.41
COVERAGE CHECK		
Permissible Coverage area (75.00 %)		34.81
Proposed Coverage Area (61.84 %)		28.70
Achieved Net coverage area (61.84 %)		28.70
Balance coverage area left (13.17 %)		6.11
FAR CHECK		
Permissible F.A.R. as per zoning regulation 2015 (1.75)		81.22
Additional F.A.R within Ring I and II (for amalgamated plot -)		0.00
Allowable TDR Area (60% of Perm.FAR)		0.00
Premium FAR for Plot within Impact Zone (-)		0.00
Total Perm. FAR area (1.75)		81.22
Residential FAR (100.00%)		56.22
Proposed FAR Area		56.22
Achieved Net FAR Area (1.21)		56.22
Balance FAR Area (0.54)		25.00
BUILT UP AREA CHECK		
Proposed BuiltUp Area		128.24
Achieved BuiltUp Area		128.24

Approval Date : 09/18/2020 4:07:46 PM

Color Notes

COLOR INDEX	
PLOT BOUNDARY	██████████
ABUTTING ROAD	██████████
PROPOSED WORK (COVERAGE AREA)	██████████
EXISTING (To be retained)	██████████
EXISTING (To be demolished)	██████████

OWNER / GPA HOLDER'S SIGNATURE

SRINATH .K

MAHARAJA .K

[Signature]
K. Maharaaja

ARCHITECT/ENGINEER /SUPERVISOR 'S SIGNATURE

RANGANATH H C
Reg NO.BCC/BL-3.6/E-2747/2005-06

[Signature]
R.H.C.

PROJECT TITLE :
PLAN SHOWING THE PROPOSED RESIDENTIAL BUILDING AT SITE NO. 87, 2nd MAIN, KUMARSWAMY LAYOUT 2nd STAGE EWS HOUSES, BANGALORE
WARD NO182 (OLD NO. 55) PID NO : 55 - 886 - 87

DRAWING TITLE : - RESIDENTIAL BUILDING

SHEET NO : 1